

- EN Quick Start Guide
- FR Guide de Démarrage Rapide
- DE Schnellstartanleitung
- IT Guida Rapida
- ES Guía de Inicio Rápido
- PL Krótki przewodnik
- RU Краткое руководство
- AR دليل البدء السريع

Detailed User Manual Download:
<https://www.augustint.com/en/download-8.html>

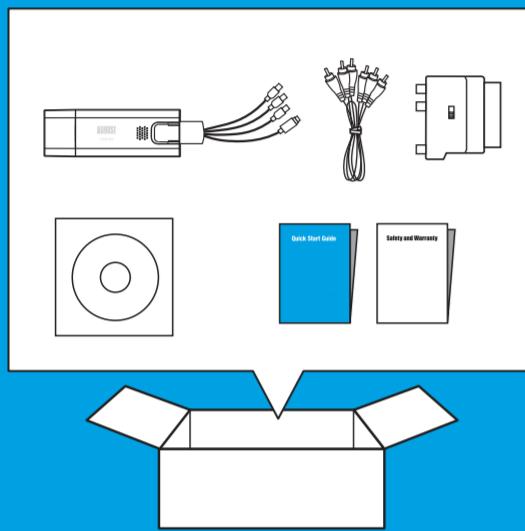

August International Ltd.
 Rawmec Business Park
 Hoddesdon EN11 0EE
 United Kingdom
 Tel: +44(0) 845 250 0586

Distributed by:
 Daffodil Germany GmbH
 Bayernstr. 10
 D-30855 Langenhagen
 Germany
 Tel: +49 (0) 511 97812978
www.augustint.com



<https://augustint.com/en/downloads/soft-9.html>
August VGB100 USB2.0 Video Capture Adaptor

For Windows 10, 8, 7, Vista, XP
 (Licence Key on a Green sticker)

Driver + VHS to DVD 4.0 SE

2 Antivirus **Off** (Windows Defender, Norton, Avast, Kaspersky, McAfee etc...)

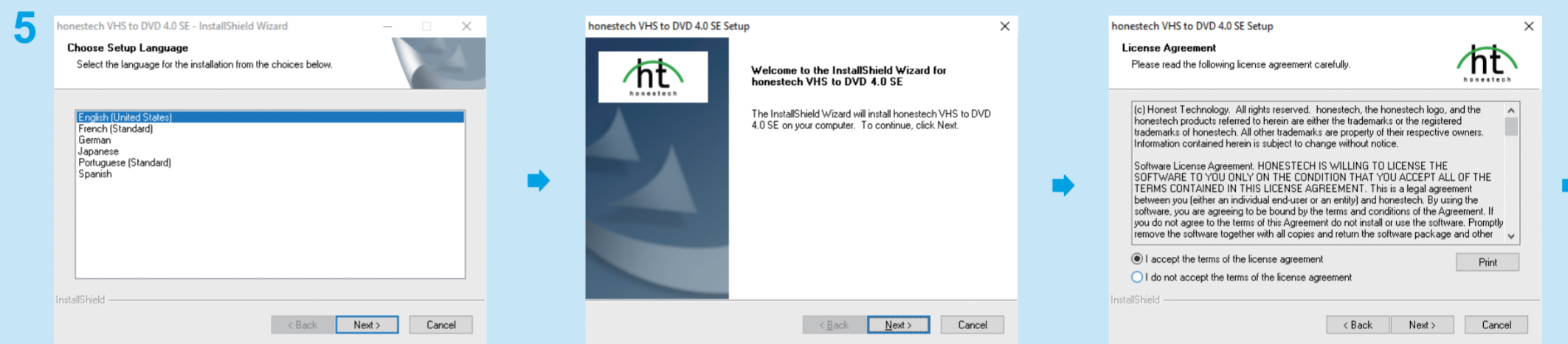
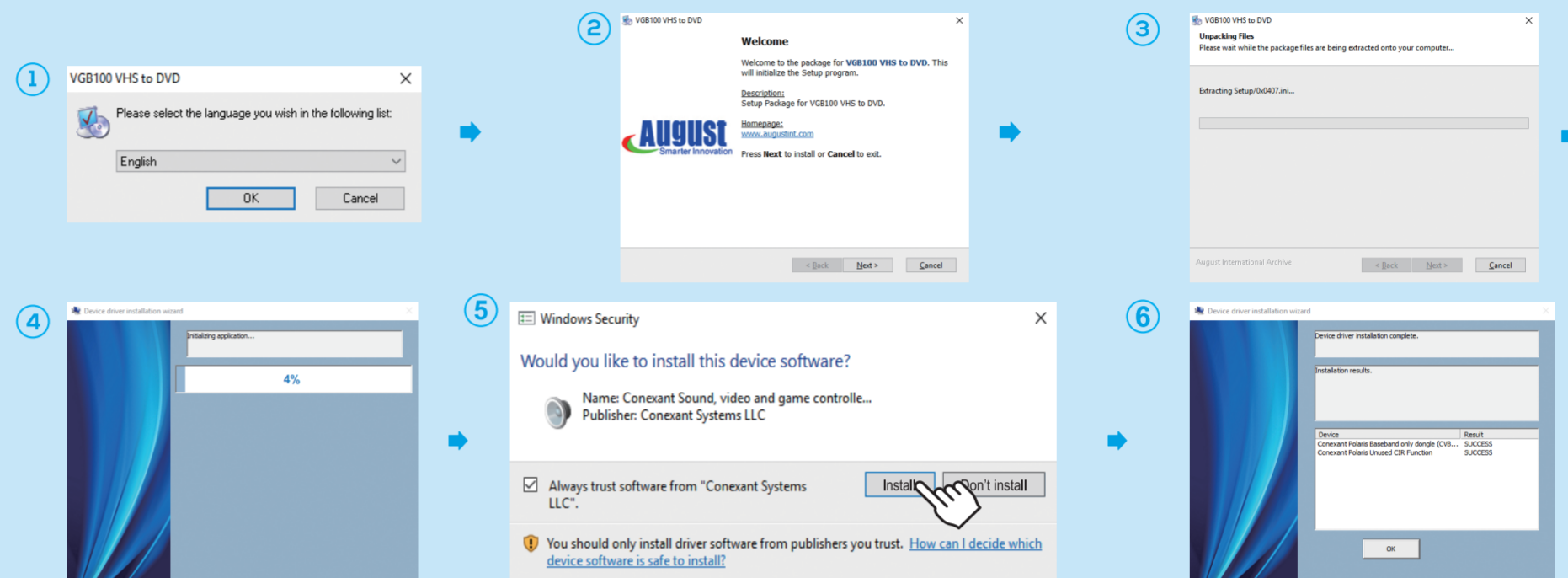
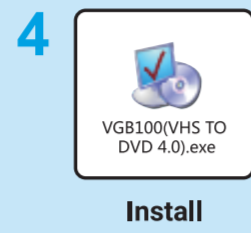
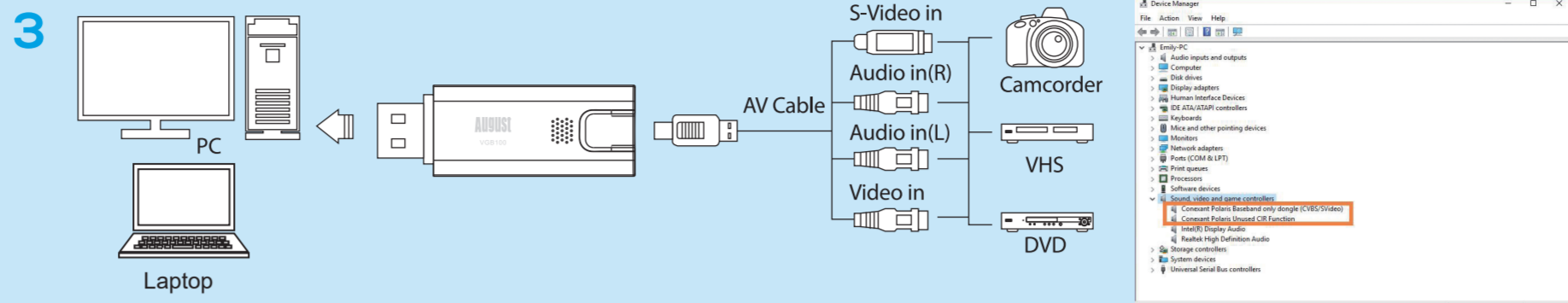

-1-

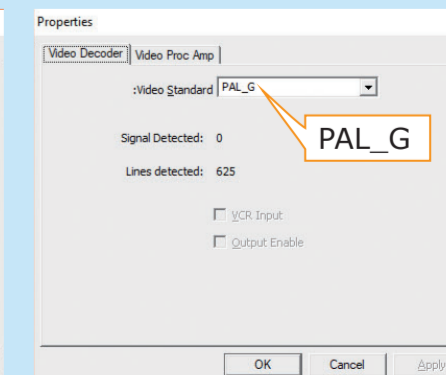
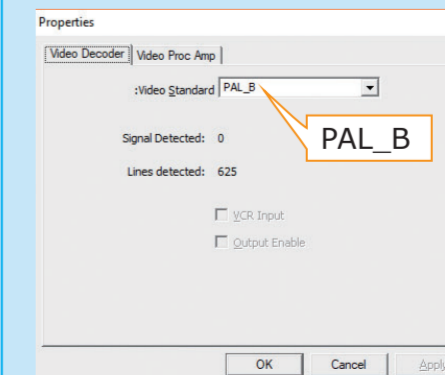
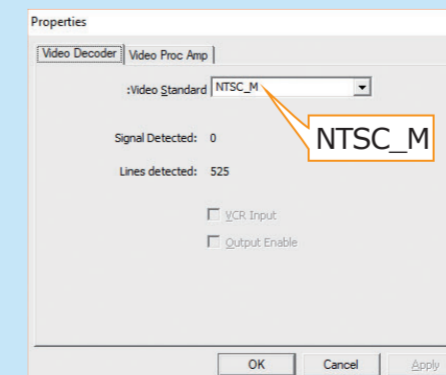
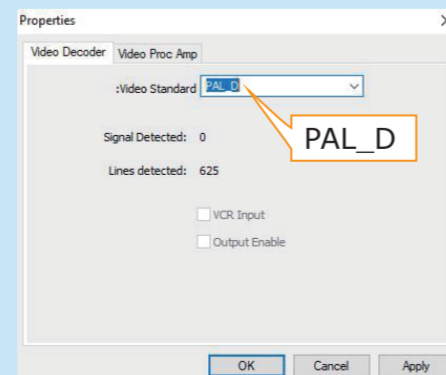
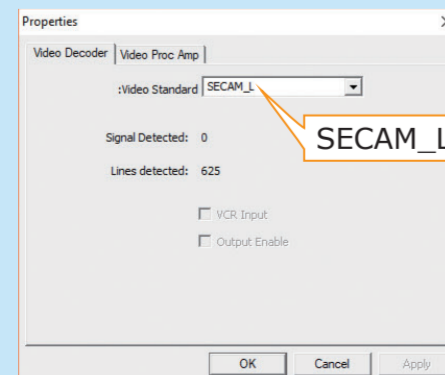
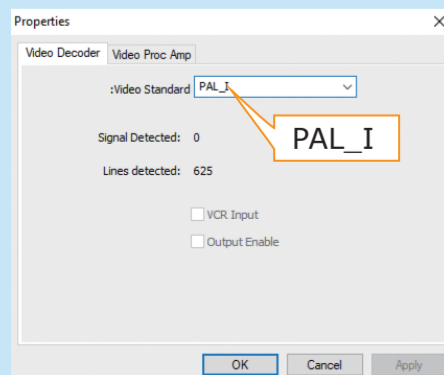
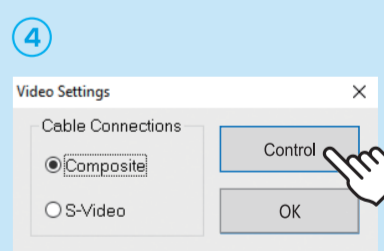
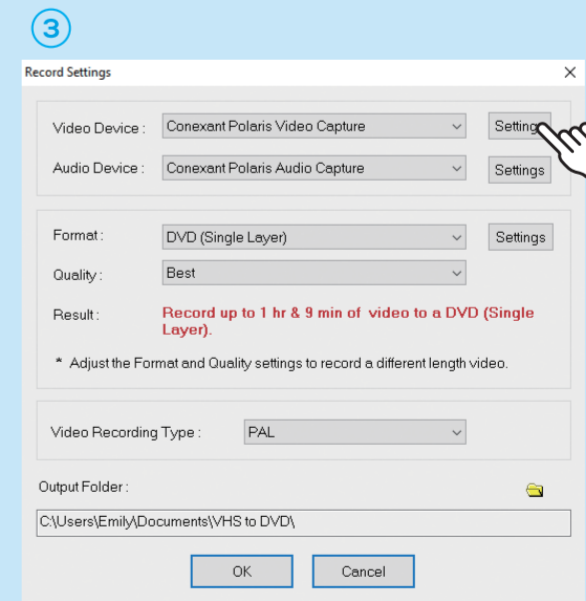
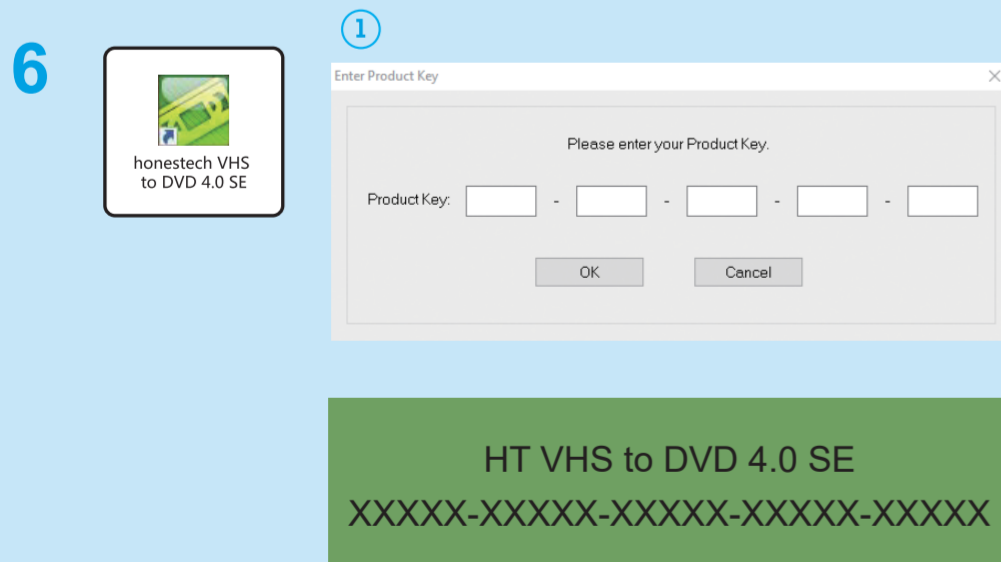
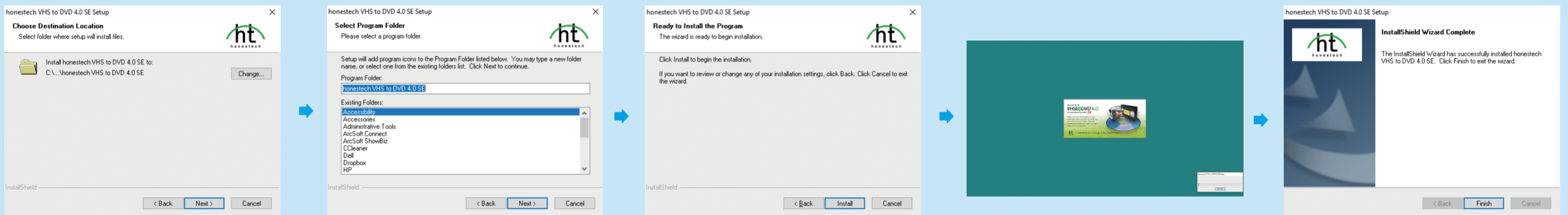

UK

FR

US

IT/DE/ES

No video
Black screen / écran noir

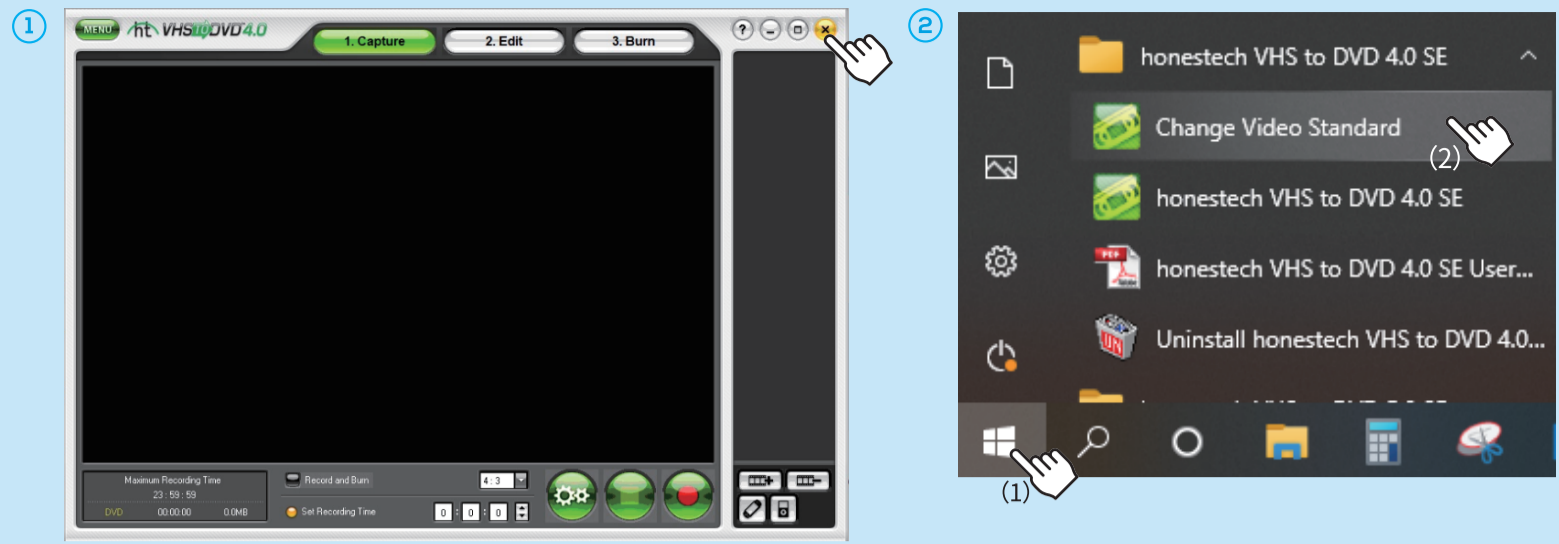

EN If you get sound but a black screen, please right click on the Honestech icon, click on Property> Compatibility and select "Reduced colour mode", and select 16-bit Colour from the drop down menu, click Apply and Ok.

FR Si vous obtenez le son mais un écran noir, veuillez faire un clic droit sur l'icône Honestech, cliquer sur Propriété > Compatibilité et sélectionner « Mode couleur réduit », 16 bits et Appliquer.

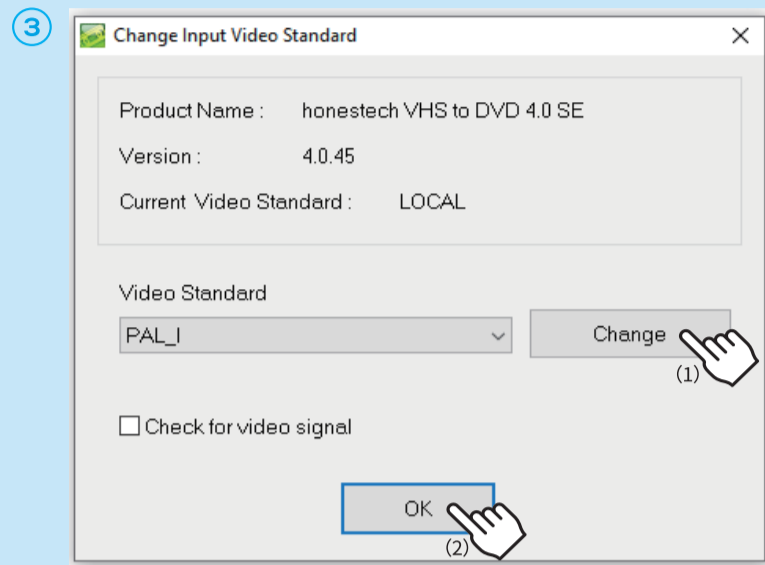

UK

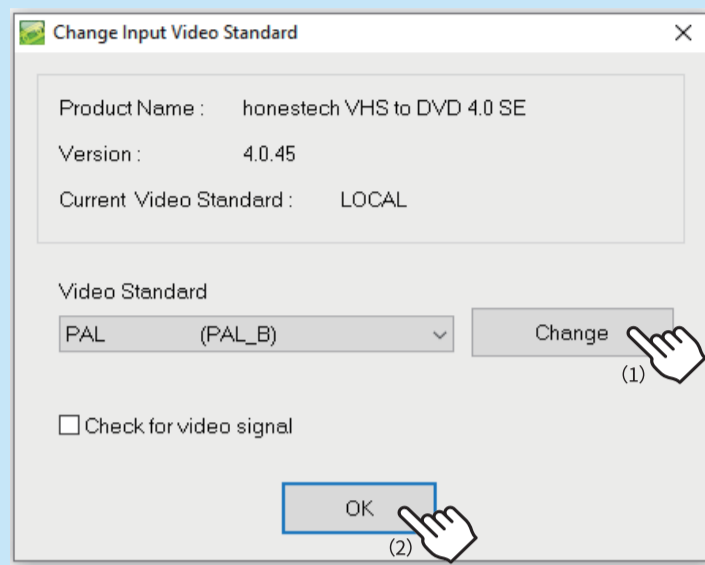

IT/DE/ES

DE Sollten Sie einen Ton hören aber einen schwarzen Bildschirm haben, klicken Sie bitte mit der rechten Maustaste auf das Honestech Desktop Icon und wählen den Punkt "Eigenschaften". Klicken Sie nun in dem darauffolgenden Fenster auf "Kompatibilität" und setzen Sie einen Haken bei "Modus mit reduzierten Farben". Stellen Sie anschließend auf 16-Bit-Farben und starten Sie das Programm neu.

IT Se ottieni il suono ma una schermata nera, fai clic con il pulsante destro del mouse sull'icona Honestech, fai clic su Proprietà> Riservatezza e seleziona "Modalità colore ridotta", quindi 16 bit.

ES Si hay sonido, pero hay una pantalla negra, por favor, haga un clic con el botón derecho del ratón en el icono de Honestech, haga un clic en Propiedades, luego Compatibilidad, y seleccione 'Modo de color reducido', 'Color de 16 bits' y Aplicare.

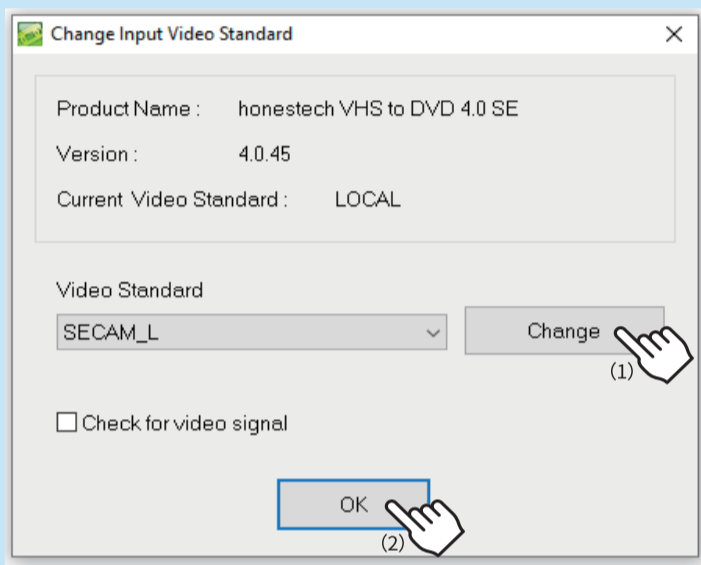

FR

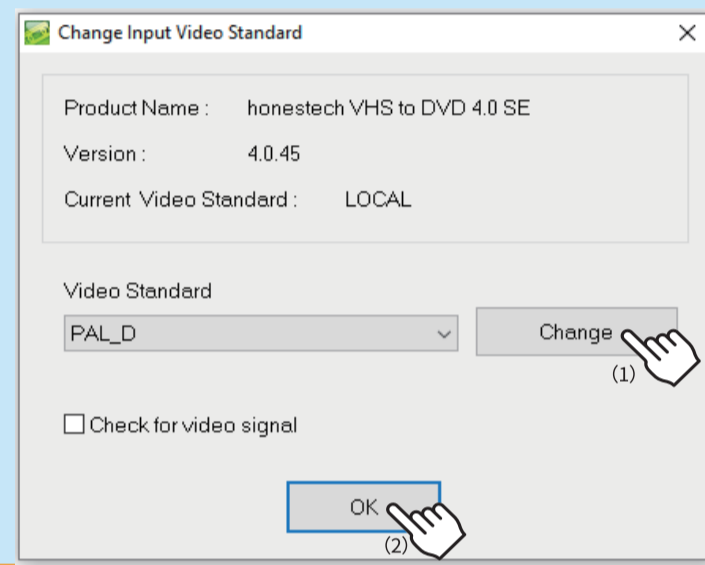

-3-

No Conexant Polaris Video Capture

1 Antivirus Off
(Windows Defender, Norton, Avast, Kaspersky, McAfee etc...)

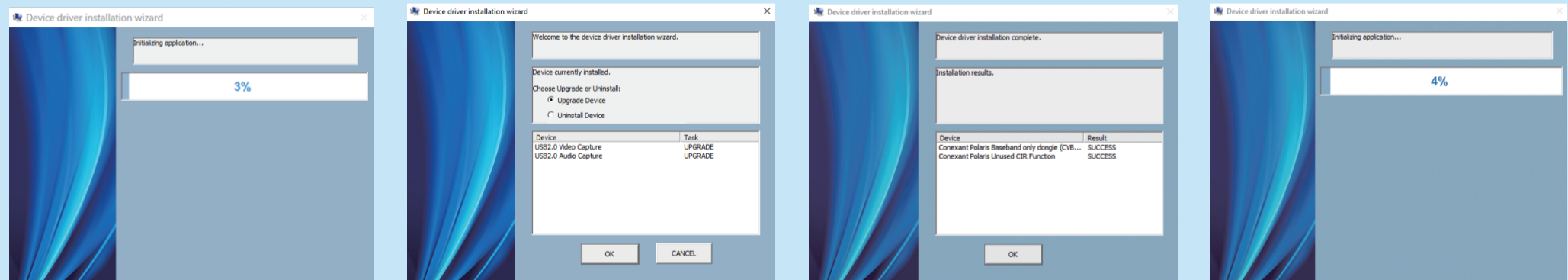
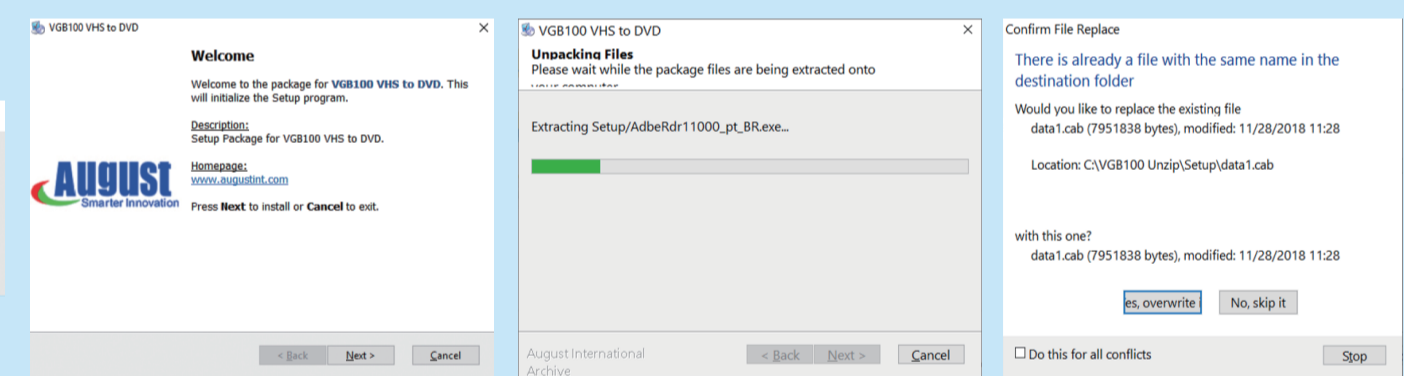
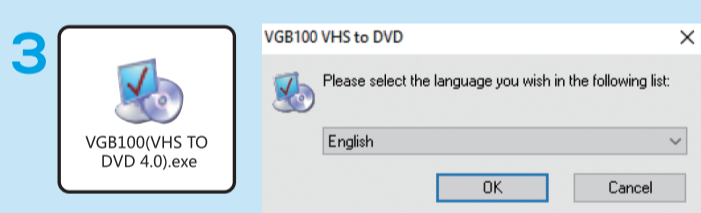
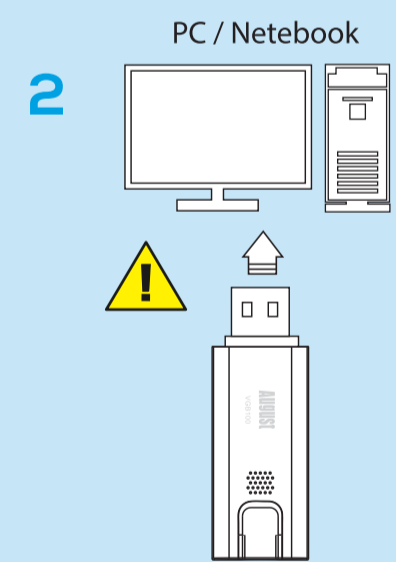

Device cannot be used / Message d'erreur



1

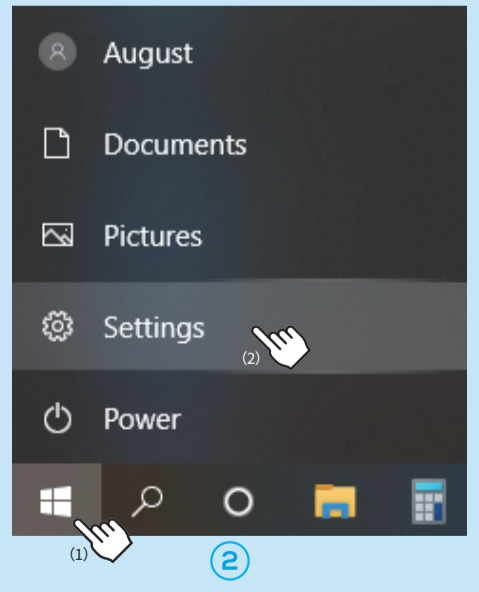

2

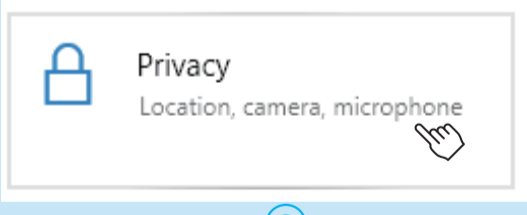

3

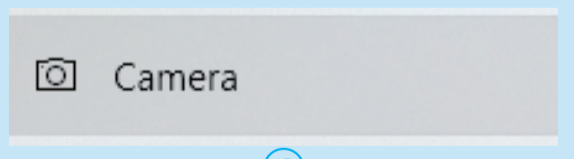

4

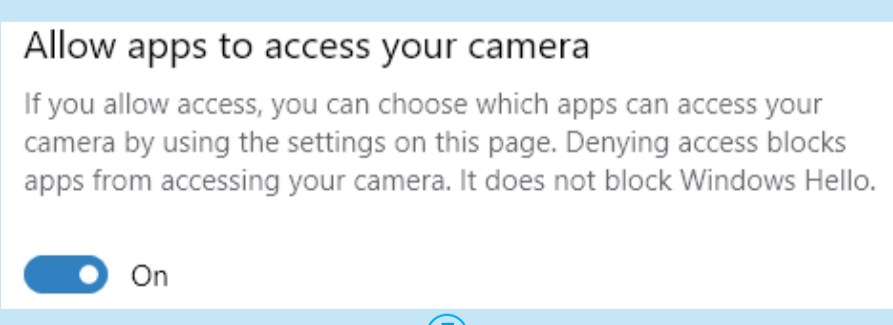

5

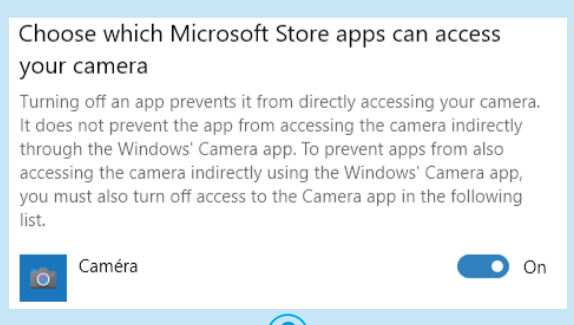

6

Blue Screen / Écran bleu

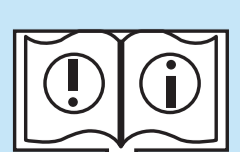
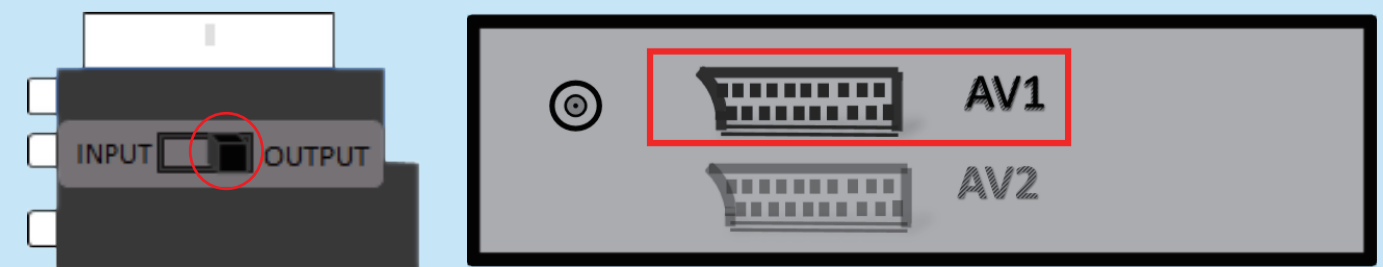

<https://augustint.com/en/VGB100>
EN Full user manual
FR Manuel d'utilisation complet
DE Vollständige Bedienungsanleitung
IT Manuale utente completo
ES Manual de usuario completo